

D-Sub Connectors

DD-Series – Straight D-Connectors

Material Specification:

Insulator:	Glass filled Polyester, Black UL94 V-0
Shell:	Stamped Steel, Tin Plated
Contact pins:	Copper Alloy, Stamped & Formed
Contact Plating:	Selective Gold over Nickel as standard Class 3, 100 inserts min. Other class on request

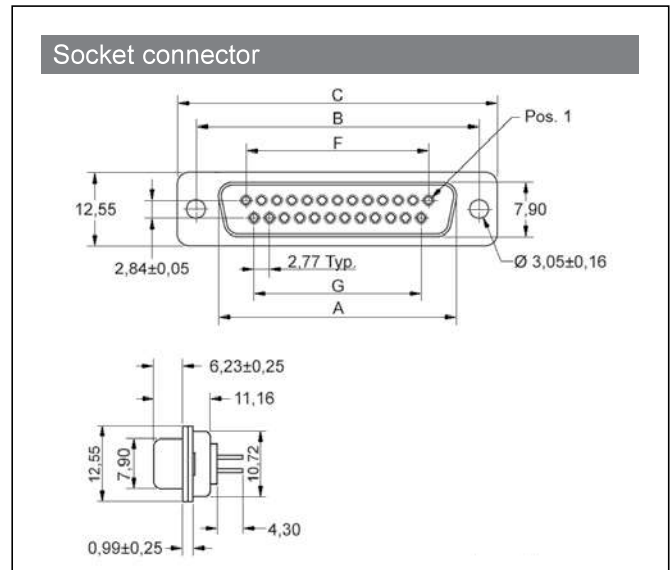
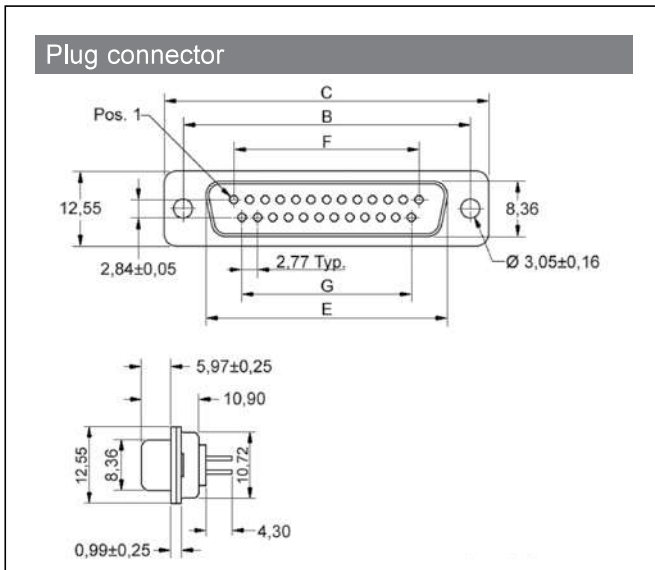

Size	A	B	C	D	E	F	G
9	16,92	24,99	30,81	-	16,33	11,08	8,31
15	25,25	33,32	39,14	-	24,66	19,39	16,62
25	38,96	47,04	53,04	-	38,38	33,24	30,47
37	55,25	63,50	69,32	-	54,84	49,86	47,09
50*	Available on request						

Order Codes - Standard Type - with Ø 3.05mm Through Hole

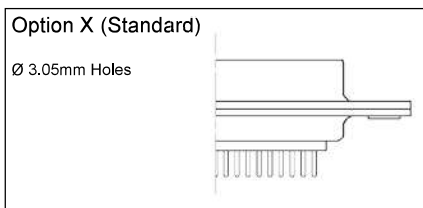

Plug Connector		
09	2103-0100-01	DD09-MTBS
15	2103-0100-02	DD15-MTBS
25	2103-0100-03	DD25-MTBS
37	2103-0100-04	DD37-MTBS
50	2103-0100-05	DD50-MTBS

Socket Connector		
09	2103-0100-11	DD09-FTBS
15	2103-0100-12	DD15-FTBS
25	2103-0100-13	DD25-FTBS
37	2103-0100-14	DD37-FTBS
50	2103-0100-15	DD50-FTBS



D-Sub Connectors

Order Codes - Option K - Back Nut UNC 4-40

Option K

Back Nut, UNC 4-40

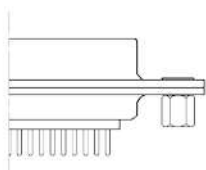

Plug Connector

09	2103-0101-01	DD09-MTBS-K
15	2103-0101-02	DD15-MTBS-K
25	2103-0101-03	DD25-MTBS-K
37	2103-0101-04	DD37-MTBS-K
50	2103-0101-05	DD50-MTBS-K

Socket Connector

09	2103-0101-11	DD09-FTBS-K
15	2103-0101-12	DD15-FTBS-K
25	2103-0101-13	DD25-FTBS-K
37	2103-0101-14	DD37-FTBS-K
50	2103-0101-15	DD50-FTBS-K

Order Codes - Option J - Front Nut UNC 4-40

Option J

Front Nut, UNC 4-40

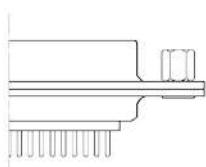

Plug Connector

09	2103-0102-01	DD09-MTBS-J
15	2103-0102-02	DD15-MTBS-J
25	2103-0102-03	DD25-MTBS-J
37	2103-0102-04	DD37-MTBS-J
50	2103-0102-05	DD50-MTBS-J

Socket Connector

09	2103-0102-11	DD09-FTBS-J
15	2103-0102-12	DD15-FTBS-J
25	2103-0102-13	DD25-FTBS-J
37	2103-0102-14	DD37-FTBS-J
50	2103-0102-15	DD50-FTBS-J

Order Codes - Option KJ - Back Nut + Screw Nut UNC 4-40

Option KJ

Back Nut, UNC 4-40 +
Screw Nut, UNC 4-40

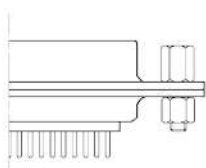

Plug Connector

09	2103-0103-01	DD09-MTBS-KJ
15	2103-0103-02	DD15-MTBS-KJ
25	2103-0103-03	DD25-MTBS-KJ
37	2103-0103-04	DD37-MTBS-KJ
50	2103-0103-05	DD50-MTBS-KJ

Socket Connector

09	2103-0103-11	DD09-FTBS-KJ
15	2103-0103-12	DD15-FTBS-KJ
25	2103-0103-13	DD25-FTBS-KJ
37	2103-0103-14	DD37-FTBS-KJ
50	2103-0103-15	DD50-FTBS-KJ

Order Codes - Option BR - Brackets for PCB with inner thread UNC 4-40

Option BR

Brackets for PCB
Inner thread UNC 4-40

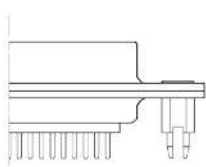

Plug Connector

09	2103-0104-01	DD09-MTBS-BR
15	2103-0104-02	DD15-MTBS-BR
25	2103-0104-03	DD25-MTBS-BR
37	2103-0104-04	DD37-MTBS-BR
50	2103-0104-05	DD50-MTBS-BR

Socket Connector

09	2103-0104-11	DD09-FTBS-BR
15	2103-0104-12	DD15-FTBS-BR
25	2103-0104-13	DD25-FTBS-BR
37	2103-0104-14	DD37-FTBS-BR
50	2103-0104-15	DD50-FTBS-BR

Order Codes - Option BR - Brackets for PCB with Screw Nut UNC 4-40

Option BRJ

Brackets for PCB +
Screw Nut, UNC 4-40

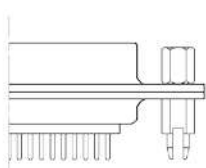

Plug Connector

09	2103-0105-01	DD09-MTBS-BRJ
15	2103-0105-02	DD15-MTBS-BRJ
25	2103-0105-03	DD25-MTBS-BRJ
37	2103-0105-04	DD37-MTBS-BRJ
50	2103-0105-05	DD50-MTBS-BRJ

Socket Connector

09	2103-0105-11	DD09-FTBS-BRJ
15	2103-0105-12	DD15-FTBS-BRJ
25	2103-0105-13	DD25-FTBS-BRJ
37	2103-0105-14	DD37-FTBS-BRJ
50	2103-0105-15	DD50-FTBS-BRJ



Encitech Connectors AB

Rörkullsvägen 4
SE-302 41 HALMSTAD, Sweden

Tel: +46-(0)35-15 13 90
e-mail: connectors@encitech.com

www.encitech.com