

D-Sub Connectors

DD-Series – Straight D-Connectors

Material Specification:

Insulator: Glass filled Polyester, Black
UL94 V-0

Shell: Stamped Steel, Tin Plated

Contact pins: Copper Alloy, Machined

Contact Plating: Selective Gold over Nickel as standard
Class 1, 500 inserts min.
Other class on request

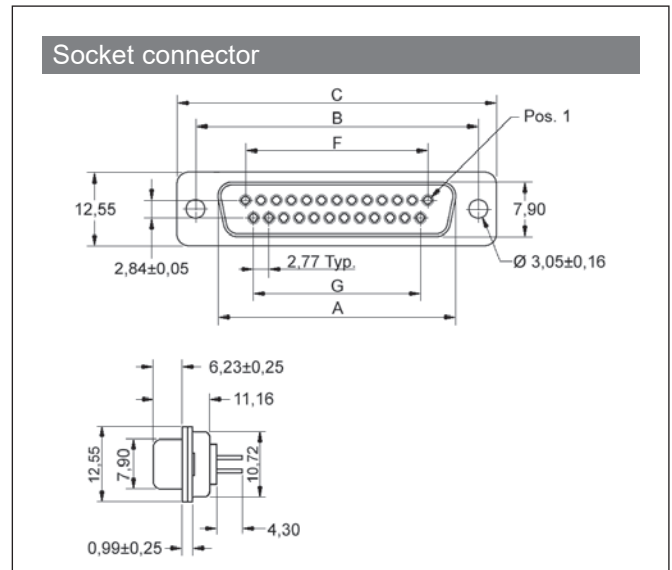
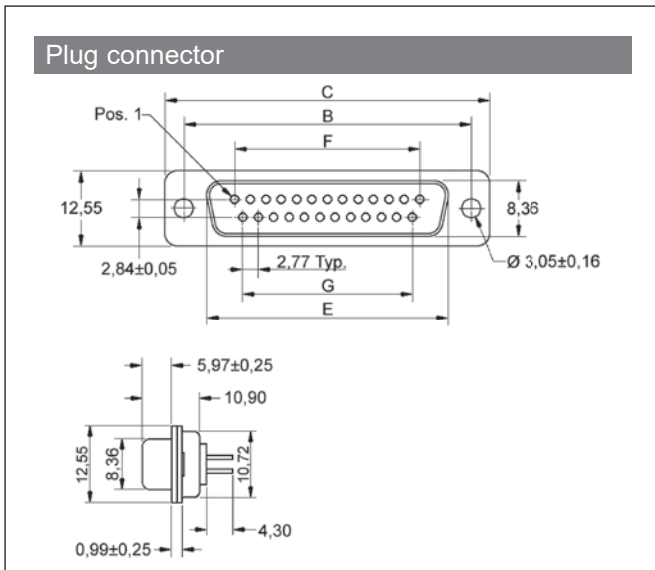
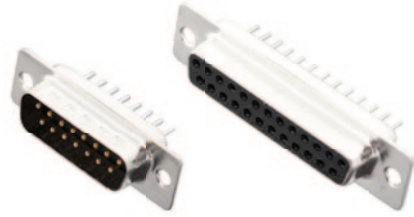

Size	A	B	C	D	E	F	G
9	16,92	24,99	30,81	-	16,33	11,08	8,31
15	25,25	33,32	39,14	-	24,66	19,39	16,62
25	38,96	47,04	53,04	-	38,38	33,24	30,47
37	55,25	63,50	69,32	-	54,84	49,86	47,09
50*	Available on request						

Order Codes - Standard Type - with Ø 3.05mm Through Hole

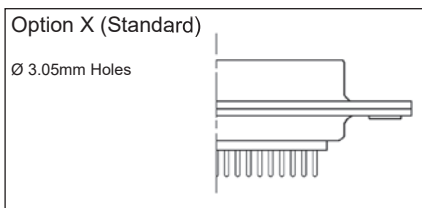

Plug Connector		
09	2103-0200-01	DD09-MTBM
15	2103-0200-02	DD15-MTBM
25	2103-0200-03	DD25-MTBM
37	2103-0200-04	DD37-MTBM
50	2103-0200-05	DD50-MTBM

Socket Connector		
09	2103-0200-11	DD09-FTBM
15	2103-0200-12	DD15-FTBM
25	2103-0200-13	DD25-FTBM
37	2103-0200-14	DD37-FTBM
50	2103-0200-15	DD50-FTBM



Encitech AB
Rörkullsvägen 4
SE-302 41 HALMSTAD, Sweden

Tel: +46-(0)35-15 13 90
e-mail: connectors@encitech.com

www.encitech.com

D-Sub Connectors

Order Codes - Option K - Back Nut UNC 4-40

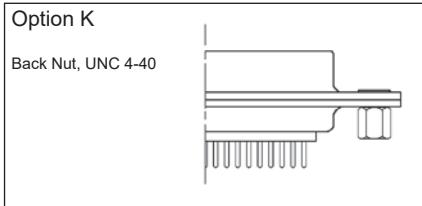

Plug Connector		
09	2103-0201-01	DD09-MTBM-K
15	2103-0201-02	DD15-MTBM-K
25	2103-0201-03	DD25-MTBM-K
37	2103-0201-04	DD37-MTBM-K
50	2103-0201-05	DD50-MTBM-K

Socket Connector		
09	2103-0201-11	DD09-FTBM-K
15	2103-0201-12	DD15-FTBM-K
25	2103-0201-13	DD25-FTBM-K
37	2103-0201-14	DD37-FTBM-K
50	2103-0201-15	DD50-FTBM-K

Order Codes - Option J - Front Nut UNC 4-40

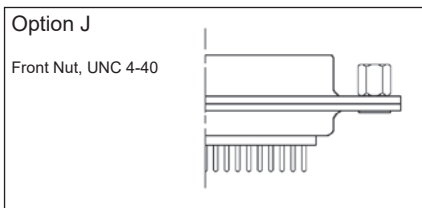

Plug Connector		
09	2103-0202-01	DD09-MTBM-J
15	2103-0202-02	DD15-MTBM-J
25	2103-0202-03	DD25-MTBM-J
37	2103-0202-04	DD37-MTBM-J
50	2103-0202-05	DD50-MTBM-J

Socket Connector		
09	2103-0202-11	DD09-FTBM-J
15	2103-0202-12	DD15-FTBM-J
25	2103-0202-13	DD25-FTBM-J
37	2103-0202-14	DD37-FTBM-J
50	2103-0202-15	DD50-FTBM-J

Order Codes - Option KJ - Back Nut + Screw Nut UNC 4-40

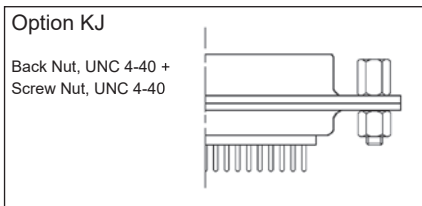

Plug Connector		
09	2103-0203-01	DD09-MTBM-KJ
15	2103-0203-02	DD15-MTBM-KJ
25	2103-0203-03	DD25-MTBM-KJ
37	2103-0203-04	DD37-MTBM-KJ
50	2103-0203-05	DD50-MTBM-KJ

Socket Connector		
09	2103-0203-11	DD09-FTBM-KJ
15	2103-0203-12	DD15-FTBM-KJ
25	2103-0203-13	DD25-FTBM-KJ
37	2103-0203-14	DD37-FTBM-KJ
50	2103-0203-15	DD50-FTBM-KJ

Order Codes - Option BR - Brackets for PCB with inner thread UNC 4-40

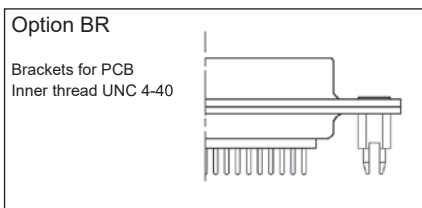

Plug Connector		
09	2103-0204-01	DD09-MTBM-BR
15	2103-0204-02	DD15-MTBM-BR
25	2103-0204-03	DD25-MTBM-BR
37	2103-0204-04	DD37-MTBM-BR
50	2103-0204-05	DD50-MTBM-BR

Socket Connector		
09	2103-0204-11	DD09-FTBM-BR
15	2103-0204-12	DD15-FTBM-BR
25	2103-0204-13	DD25-FTBM-BR
37	2103-0204-14	DD37-FTBM-BR
50	2103-0204-15	DD50-FTBM-BR

Order Codes - Option BR - Brackets for PCB with Screw Nut UNC 4-40

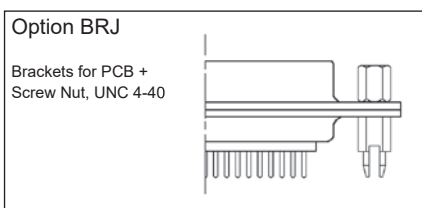

Plug Connector		
09	2103-0205-01	DD09-MTBM-BRJ
15	2103-0205-02	DD15-MTBM-BRJ
25	2103-0205-03	DD25-MTBM-BRJ
37	2103-0205-04	DD37-MTBM-BRJ
50	2103-0205-05	DD50-MTBM-BRJ

Socket Connector		
09	2103-0205-11	DD09-FTBM-BRJ
15	2103-0205-12	DD15-FTBM-BRJ
25	2103-0205-13	DD25-FTBM-BRJ
37	2103-0205-14	DD37-FTBM-BRJ
50	2103-0205-15	DD50-FTBM-BRJ

