

DATE	REV	ECN	APP'D. BY
1-5-15	A6	10169	TRM
3-16-16	A7	10612	TRM

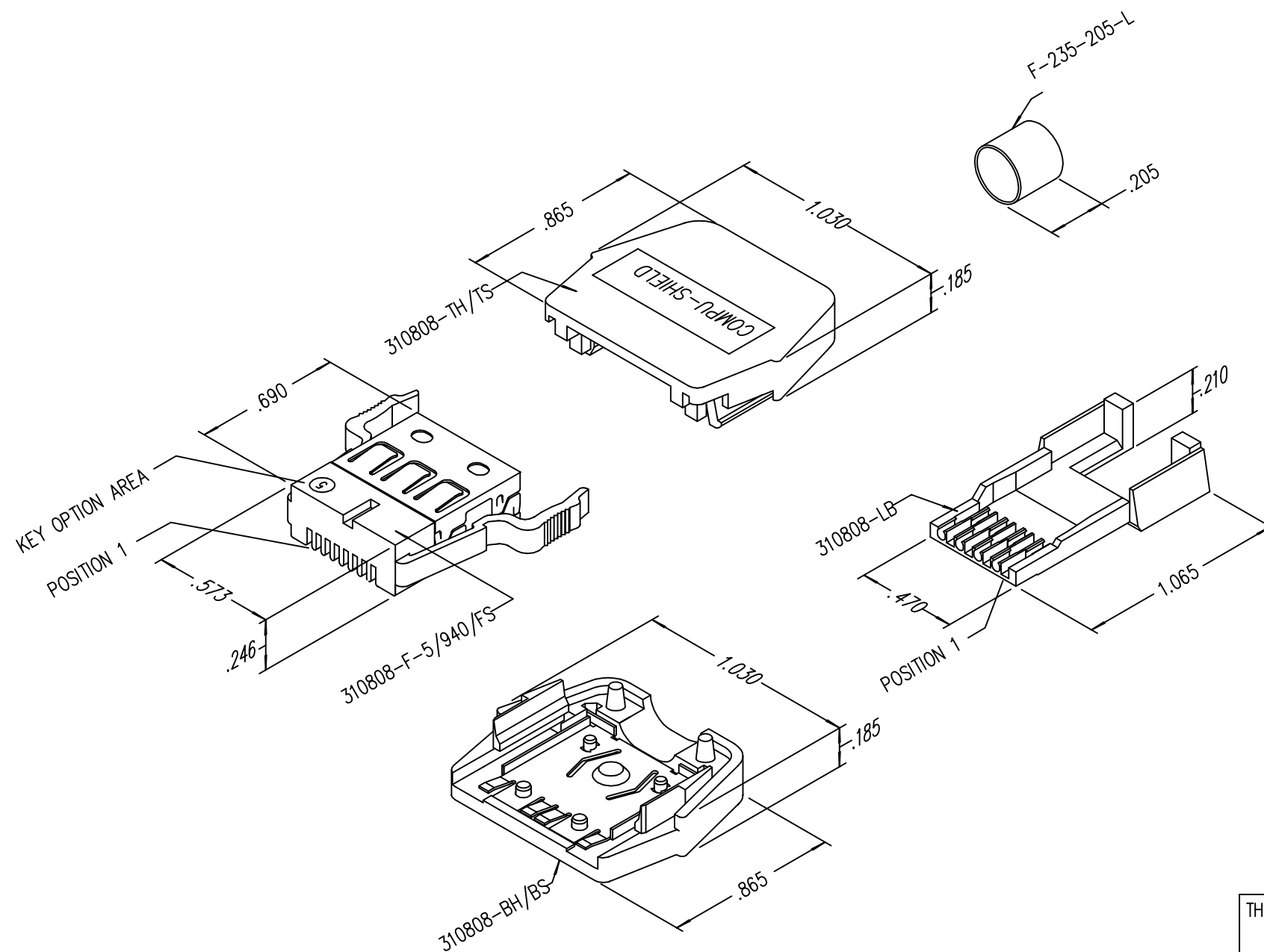

NOTES:

- PLUG MATERIALS:  
 TOP/BOTTOM HOUSING: PC UL94 V-0 COLOR: BLACK  
 FRONT PLASTIC: PC UL94 V-0 COLOR: CLEAR  
 LOAD BAR: PC UL94 V-0 COLOR: CLEAR  
 CONTACTS/SHIELD: COPPER ALLOY  
 SHIELD PLATING: TIN  
 FERRULE PLATING: NICKEL OR TIN  
 CONTACT PLATING: SELECTIVE GOLD IN CONTACT AREA  
 SEE CHART FOR PART NUMBER
- CONTACTS TERMINATE SOLID OR STRANDED CONDUCTORS UP TO .042" OUTSIDE DIAMETER OF INSULATION
- DIMENSIONS AND TOLERANCES COMPLY WITH TIA-1096 STANDARD.
- HOUSING WILL ACCEPT CABLE UP TO .220" OUTSIDE DIAMETER OF JACKET
- FOR PRODUCT SPECIFICATIONS SEE PRO26-01
- TERMINATED PLUG HEIGHT .234±.002 ON CABLE

50 MICRO-INCHES [1.27um]	SS-310808-5
CONTACT PLATING IN MATING AREA	PART NUMBER

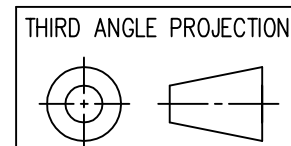

1118 Susquehanna Trail South  
 Glen Rock, PA 17327-9199  
 (717) 235-7512  
<http://www.stewartconnector.com>

DO NOT SCALE DRAWING  
 DRAWING IS SUBJECT TO CHANGE WITHOUT NOTICE

TITLE: 8X8 COMPU-SHIELD PLUG FINAL ASSEMBLY

DIMENSIONS: INCHES [METRIC]  
 UNLESS OTHERWISE SPECIFIED TOLERANCES ARE ±.005 [0.13] ANGLES ARE ± 1°

THIS DRAWING AND THE SUBJECT MATTER SHOWN THEREON ARE CONFIDENTIAL AND THE PROPRIETARY PROPERTY OF STEWART CONNECTOR AND SHALL NOT BE REPRODUCED, COPIED, OR USED IN ANY MANNER WITHOUT PRIOR WRITTEN CONSENT OF STEWART CONNECTOR. ONE OR MORE U.S. PATENTS MAY APPLY TO THIS PRODUCT. FOR DETAILS, PLEASE VISIT: [HTTP://BELFUSE.COM/STEWART/STEWART\\_PATENTS/](http://BELFUSE.COM/STEWART/STEWART_PATENTS/)

DRN BY:	KRL	DATE	1/31/06
APPD BY:	JM	DATE	2-1-06
DWG NO.	CT310004	REV.	A7

SHEET NO. 1 OF 1

